

SM1100 BACKUP UPS



USER GUIDE

Model No: TR200601 937Y

WARRANTY CONDITIONS

- 1) 2 Year Warranty. The warranty period begins on the date of delivery of the product.
- 2) All parts of the product are under the warranty of our company.
- 3) In case the product fails within the warranty period, the time spent in repair is added to the warranty period. The repair time of the product is maximum 30 business days. This period starts from the date of notification to the service station of the product related malfunction, to the seller, dealer, agent, importer or manufacturer of the product in the absence of the service station.
- 4) If the product fails due to material and workmanship defects within the warranty period, will be repaired without any charge under the cost of labor, changing parts, etc.
- 5) Malfunctions resulting from the use of the product contrary to the points in the user manual are out of warranty.

UPS INSTALLATION

Select Location

Since the UPS works with a remote control system, it should be mounted close to the exterior. Otherwise, the control distance will be shorter. The place where the UPS will be installed should be visible, and where in case of a malfunction it will be easy to get to the device.

The UPS should be mounted away from areas that may generate magnetic fields (electrical wiring lines, electrical panels, etc.). UPS should not be installed in humid, sunny and hot environments.

CONTROL BOARD

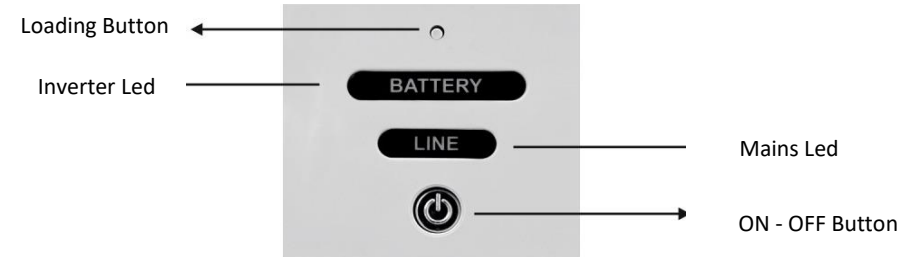

LOADING BUTTON: Used for remote control identification and memory deletion.

BATTERY: Indicates that the battery is charged when there is mains electricity and that it outputs if the device is operated with a remote control when there is no mains electricity.

LINE : If there is mains electricity, the Line light is on steadily. If there is no mains electric, the Line light flashes and blinks.

ELECTRICITY INPUT INSURANCE: Overcurrent insurance.

ON - OFF BUTTON: Used for UPS's on-off operations.

INSTALLATION - SINGLE OUTLET

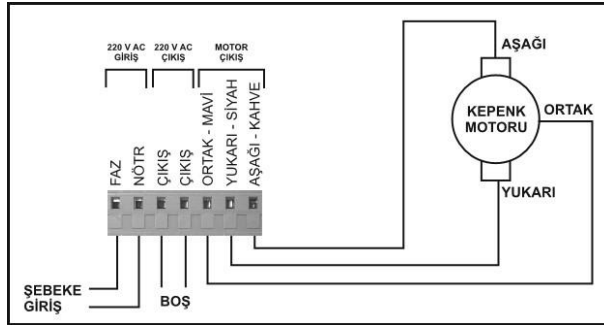

Used in places with 1 shutter

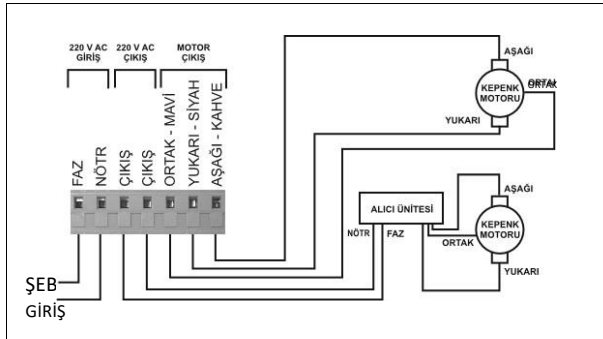

Used in places with 2 shutters

It is used in places with 2 shutters. Button 1 of the controller is loaded to UPS, button 2 is loaded to the receiver unit.

Attention: Shutters should be operated sequentially.

LOADING REMOTE CONTROL TO MEMORY

Turn the "ON-OFF" switch on the UPS 1 to 1 ON 1, press the button on the remote control, press the 1 LOADING button on the UPS at the same time, the battery led will flash and the buzzer will sound. As soon as you take your hand off the buttons, the loading process will be done. In this way, you can upload 42 passwords to the UPS. The loading process will be enough to load only one of the buttons (1-2) on the control and if you load more buttons, it will occupy memory. Contact your dealer to upload more than 42 passwords.

DELETING A REMOTE CONTROL FROM THE MEMORY





Turn the "ON-OFF 1 switch to 2 OFF" position on the UPS. Press and hold up button. Turn the ON-OFF 2 switch to the "ON" position.

Attention: When the deletion is done, all the controls introduced to the memory will be deleted from the memory.

CHARGE

If the mains power is available, the UPS will automatically start charging even if the UPS is off. Make sure your shutter works from the batteries by cutting the mains electricity coming to the UPS once every 2 months. In this way, you will ensure that the batteries are discharged and then charged, like this you will extend the life of the batteries.

SAFETY NOTICES

-  This manual contains important safety instructions. Please follow all instructions in order during the installation phase. Read this manual carefully before commissioning the device.
-  To prevent the risk of fire and electric shock, install the device in a closed area with temperature and humidity control.
-  Risk of **electric shock!** Even if no mains electric is connected inside the UPS, live spots can be energized and create danger due to the battery power supply.
-  This UPS is designed for automatic shutter systems only and cannot be used for other purposes.

FAILURE CASES

If UPS does not work in case of power failure

UPS I's batteries may be faulty, the cradle may be defective. Talk to your dealer.

UPS control distance is short. The battery of your controller may be exhausted, dense electrical cables are passing through the regions close to the antenna of the UPS, there may be intensity (interference) in the 433 MHz band. Talk to your dealer. If the shutter works in one direction Motor output ends may be connected incorrectly.

Straighten the cables The UPS may have malfunctioned due to a bad connection. Talk to your dealer.

If the shutter does not work in case of power failure

Shutters may be stuck; batteries may be empty. Talk to your dealer.

If the led is not light UPS may not be receiving electricity. The fuse may have blown.

Technical Specification

Model	: 1100
Power	: 1000 W
Input Voltage	: 220 VAC, 1 phase
Input Frequency	: 50/60 Hz
Output Voltage	: 220 VAC, 1 phase
Output Frequency	: 50/60 Hz
Grid Operation Range	: 170-230 VAC
RF Operation Frequency	: 433,92 MHz
Battery Type	: Maintenance free dry type
Battery No & Warranty	: 2 pcs 12 V 7 Ah / 2 Year
Charge Period	: 12 hours
Standby Period	: 4 Days (100 Hours)
Remote Controller Range	: 30 Meter
Alarms & Warnings Indicators	: warning on operation from the battery, no network warning
Protection	: Grid Voltage (Line) and Inverter (Battery) warning led
Operation Temperature	: Excessive load protection, short circuit protection
Net & Lifting Weight	: 0°C - 50°C
Dimensions	: 6.4 kg / 160- 220 kg
Options	: 370 x 320 x 150 mm
	: External receiver, 42 pieces remote controller